

Varenummer: 03550040

Beskrivelse: Fluro hydraulik ledhoved FPR 40S

Mål

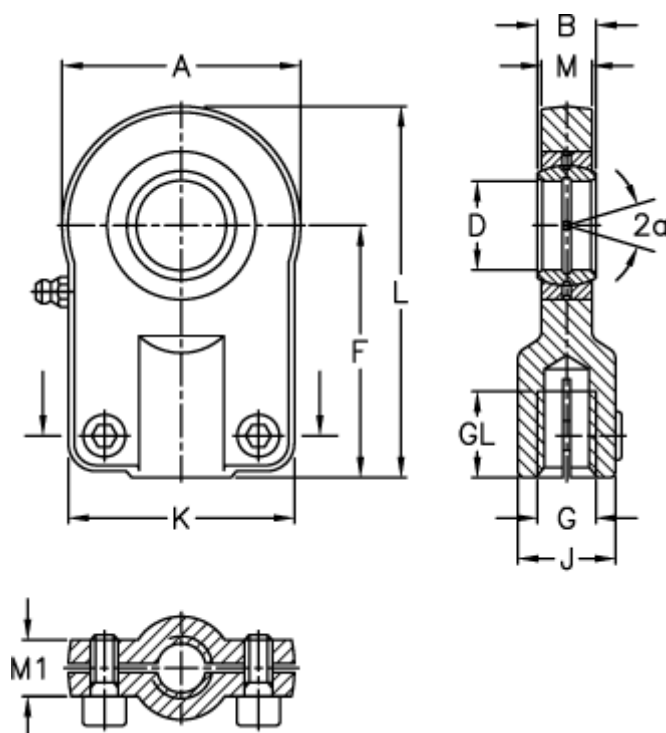

A	= 100	J	= 45
a (grader)	= 7	K	= 90
B	= 28	L	= 155
D	= 40	M	= 23
Dynamisk belastning C (kN)	= 100	M1	= 23
F	= 105	Moment (Nm)	= 49
g	= M27x2	Statisk belastning C0 (kN)	= 156
GL	= 37	Vægt	= 2300